

10 Accessories

10a Door Stops & Cabinet Knobs

6 Door Stops

11 Cabinet Knobs

13 Coathook, Card Frames

14 Cable Box

Door Stops

38 3816 

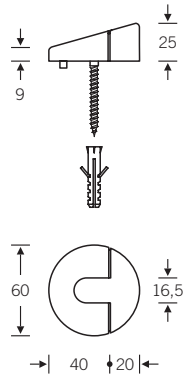

38 3817 

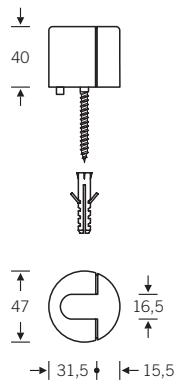

Before placing an order or carrying out any installation, please check the weight of the door leaf, the angle of impact, the height of the bottom edge of the door above the floor and the strength of the floor. Depending on requirements, it is possible to choose between simple stops,

stops with anti-twist capability, stops with baseplates, directional and non-directional stops and stops fitted straight into the floor or those where rawplugs are used.

All details subject to modification

Door Stops

38 3878 

Design: Christoph Ingenhoven

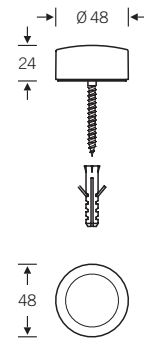

38 3880 

38 3880 00001 (Black rubber)

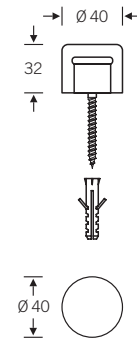

All details subject to modification

Before placing an order or carrying out any installation, please check the weight of the door leaf, the angle of impact, the height of the bottom edge of the door above the floor and the strength of the floor. Depending on requirements, it is possible to choose between simple stops,

stops with anti-twist capability, stops with baseplates, directional and non-directional stops and stops fitted straight into the floor or those where rawplugs are used.

Door Stops

38 3880 

38 3880 00002 (120 mm)
 38 3880 00003 (90 mm)
 38 3880 00004 (60 mm)

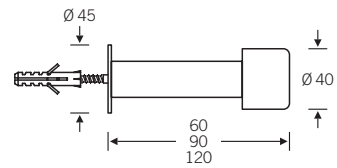

38 3881 

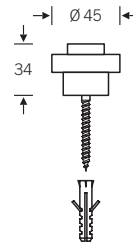

Before placing an order or carrying out any installation, please check the weight of the door leaf, the angle of impact, the height of the bottom edge of the door above the floor and the strength of the floor. Depending on requirements, it is possible to choose between simple stops,

stops with anti-twist capability, stops with baseplates, directional and non-directional stops and stops fitted straight into the floor or those where rawplugs are used.

All details subject to modification

Door Stops

38 3884 

38 3884 00000 (Door stop)
38 3884 00010 (Black baseplate)

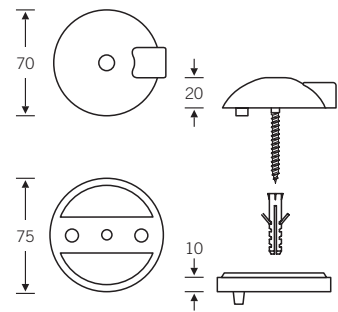

38 3895 

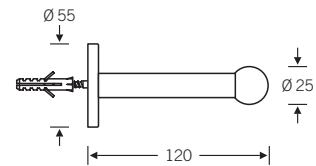

Before placing an order or carrying out any installation, please check the weight of the door leaf, the angle of impact, the height of the bottom edge of the door above the floor and the strength of the floor. Depending on requirements, it is possible to choose between simple stops,

stops with anti-twist capability, stops with baseplates, directional and non-directional stops and stops fitted straight into the floor or those where rawplugs are used.

All details subject to modification

2016/02

Coathook/Door Stop

36 3646 

36 3646 00000 (Coathook without buffer)
36 3646 00001 (Coathook and doorstop with buffer)

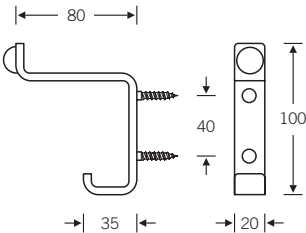

All details subject to modification

Cabinet Knobs

36 2328 ■

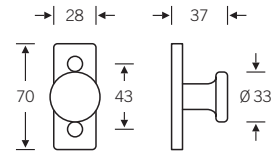

36 3632 ■* ■

Design: Philippe Starck

36 3632 004 (RH)
36 3632 005 (LH)

Supplied with M4 × 30 mm screw

* Aluminum available in natural color only

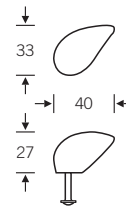

36 3654 ■ ■

Design: Jasper Morrison

Supplied with M4 × 30 mm screw

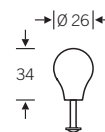

All details subject to modification

Cabinet Knobs

36 3689 ■

Supplied with M4 × 30 mm screw

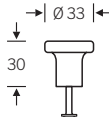

36 3691 ■■

Supplied with M4 × 30 mm screw

Design: Franco Clivio

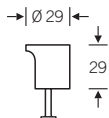

36 3656 | 36 3657 ■

36 3656 (70 mm)
36 3657 (90 mm)

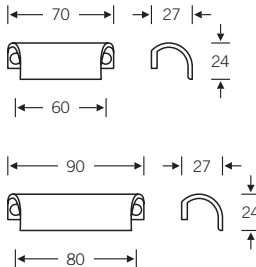

All details subject to modification

Coathook Card Frames

36 3650 ■

Design: Jasper Morrison

Coathook

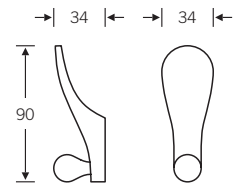

36 4001 ■

36 4001 (paper dimension 74 × 105 mm)
 36 4002 (paper dimension 37 × 105 mm)
 36 4003 (paper dimension 52 × 74 mm)
 36 4004 (paper dimension 26 × 74 mm)

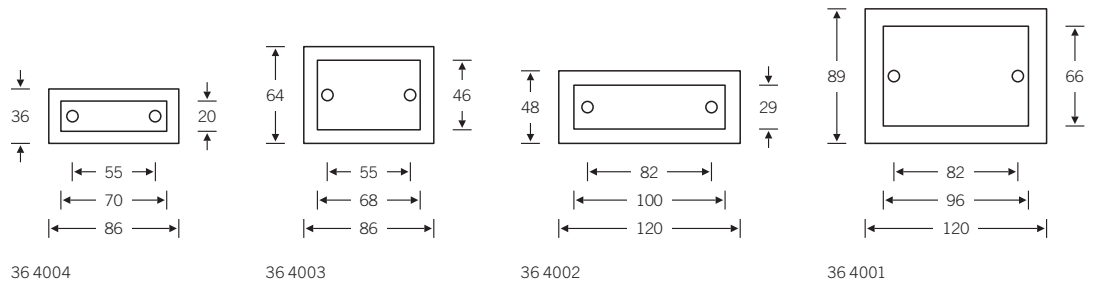

All details subject to modification

Cable Box

36 9865



Height less rim	36 9865 00000	38.0 mm
	36 9865 00002	33.0 mm
	36 9865 00004	29.0 mm
	36 9865 00005	23.0 mm

External diameter	90.0 mm
Internal diameter	80.0 mm
Inlet diameter	85.0 mm

Rim thickness	1.2 mm
Rim projection	2.5 mm
Slit length	58.0 mm

The FSB cable box ensures tidy cable management at work desks. Connections for telephones and fax machines, task lights, desktop computers and all that goes with them are ideally accommodated in this elegant cable box.

Its heavy-duty design is such that the cap remains firmly clipped in place no matter how inflexible the cabling beneath. The slit is sealed by a brush gasket that adapts itself to the cables inserted.

The FSB cable box is available in:
 Alu Natural Color Anodized
 Alu Brass Color Anodized
 Alu + Color Black
 Alu + Color White
 Alu + Color Grey
 Satin Stainless Steel

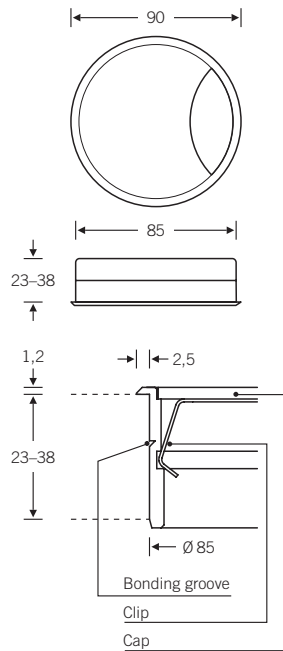

All details subject to modification