

2 Mortise Locks

2d Mortise Lock Parts

- 2 Lock Correlation Table
- 3 SML Mortise Lock Parts
- 10 NML Mortise Lock Parts
- 19 EML Mortise Lock Parts

Lock Correlation Table

Lock Body Number	Lockset Function	Lock Code
SML 7100	Active Dummy	SML Y/Z
SML 7122	Store Door	SML A
SML 7124	Dormitory	SML B
	Privacy	SML E
	Patio	SML T
	Passage	SML C
SML 7125	Passage	SML C
SML 7134	Hotel	SML D
SML 7142	Public Restroom	SML F
SML 7145	Classroom	SML G
SML 7148	Entrance	SML H
SML 7156	Office	SML I
SML 7158 (EU/EL)	Electrified Institutional	SML V (EU/EL)
SML 7159	Storeroom	SML J
SML 7159 (EU/EL)	Electrified Storeroom	SML J (EU/EL)
SML 7167	Apartment	SML K
SML 7181	Deadlock	SML M
	Deadlock	SML N
	Deadlock	SML P
	Deadlock	SML R
	Deadlock	SML S
NML 7100	Active Dummy	NML Y/Z
NML 7122	Store Door	NML A
NML 7124	Dormitory	NML B
	Privacy	NML E
	Patio	NML T
	Passage	NML C
NML 7125	Passage	NML C
NML 7142	Public Restroom	NML F
NML 7145	Classroom	NML G
NML 7148	Entrance	NML H
NML 7156	Office	NML I
NML 7159	Storeroom	NML J
NML 7181	Deadlock	NML M
	Deadlock	NML N
	Deadlock	NML P
	Deadlock	NML R
	Deadlock	NML S
EML 0001	Store Door	EML A
	Dormitory	EML B
EML 0002	Privacy	EML E
EML 0003	Passage	EML C

All details subject to modification

Standard Mortise Lock Series SML

Lock Body and Functions



Series SML

Standard Mortise Lock Body

Recommended for minimum 1 3/4" (45 mm) door thickness with standard 1 1/4" (32 mm) armor front.
 1" (25.4 mm) armor front available for doors with 1 3/8" (35 mm) door thickness.

Knob strength available.

Backsets

- 2 1/2" (64 mm)
- 2 3/4" (70 mm)
- 3 3/4" (95 mm)
- 5" (127 mm)
- 6" (152 mm)

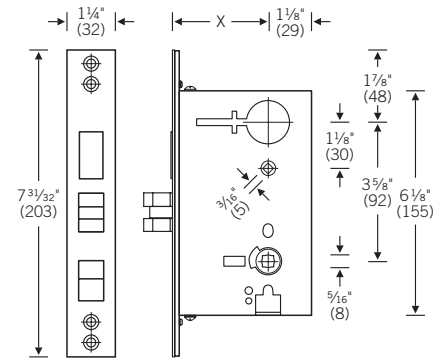

SML 7100



Active Dummy Mortise Case

Function Y

Active dummy handle either side.

Function Z

Active dummy handle single side only with blind cover on opposing side.

SML 7122



Store Door, Function A – ANSI Code F14

Latch bolt by handle either side. Deadbolt by key either side.

All details subject to modification

2016/02

Standard Mortise Lock Series SML

Lock Body and Functions

SML 7124



Dormitory, Function B – ANSI Code F13
Deadbolt by thumb turn inside and key or emergency release outside.

Privacy, Function E – ANSI Code F19
Latch bolt by handle either side. Deadbolt by thumbturn inside and emergency key outside. Use of inside handle retracts latch and deadbolt simultaneously, automatically unlocking outside handle. Outside handle is rigid when deadbolt is thrown by thumbturn.

Patio, Function T
Latch bolt by handle either side. Deadbolt by thumbturn inside. Outside handle is rigid when deadbolt is thrown by thumbturn. Use of inside handle retracts latch and deadbolt simultaneously.

SML 7125



Passage, Function C – ANSI Code F01
Latch bolt by handle either side.

SML 7134



Hotel, Function D – ANSI Code F15
Latch bolt by handle inside and guest or master key outside. Outside handle always rigid. Deadbolt by thumbturn inside and service key only outside. Use of inside handle retracts latch and deadbolt simultaneously. Auxiliary latch deadlocks latch bolt.

SML 7142



Public Restroom, Function F – ANSI Code F09
Latch bolt by handle either side unless outside handle is locked by master key from inside (cylinders are provided KD). When outside handle is locked, latch bolt by key outside and handle inside. Auxiliary latch deadlocks latch bolt.

All details subject to modification

Standard Mortise Lock Series SML

Lock Body and Functions

SML 7145



Classroom, Function G – ANSI Code F05

Latch bolt by key outside and handle either side unless outside handle is locked by key outside. Auxiliary latch deadlocks latch bolt.

SML 7148

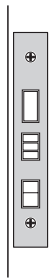

Entrance, Function H – ANSI Code F12

Latch bolt by key outside and handle either side unless outside handle is locked by toggle. Deadbolt by key outside and thumbturn inside. Inside handle retracts latch and deadbolt. Outside handle is rigid when deadbolt is thrown by key or thumbturn.

SML 7156



Office, Function I – ANSI Code F04

Latch bolt by key outside and handle either side unless outside handle is locked by toggle. Auxiliary latch deadlocks latch bolt.

SML 7159

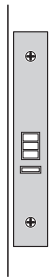

Storeroom, Function J – ANSI Code F07

Latch bolt by handle inside and key outside. Outside handle always rigid. Auxiliary latch deadlocks latch bolt.

SML 7167

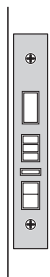

Apartment, Function K – ANSI Code F20

Same as SML 7148 with the following addition: Auxiliary latch deadlocks latch bolt and prevents manipulation of locked toggle. Outside handle is rigid when deadbolt is thrown by key or thumbturn.

All details subject to modification

Standard Mortise Lock Series SML

Lock Body and Functions

SML 7181



Deadlock

Function M – ANSI Code F18
Deadbolt by key outside. No operation inside.

Function N – ANSI Code F16
Deadbolt by key either side.

Function P – ANSI Code F17
Deadbolt by key outside and thumbturn inside.

Function R
Deadbolt by thumbturn inside. No operation outside.

Function S
Deadbolt by thumbturn inside and emergency release outside.

SML 7158 VEU/VEL

EU = fail secure
EL = fail safe



Electrified Institutional, Function VEU/VEL

Latchbolt retracted by key on either side. Switched power allows both levers to retract latchbolt.
Auxiliary latch deadlocks latch bolt.
EU = Inside and outside lever simultaneously unlocked electronically.
EL = Inside and outside lever simultaneously locked electronically.

SML 7159 JEU/JEL

EU = fail secure
EL = fail safe



Electrified Storeroom, Function JEU/JEL

Key outside retracts latch bolt, when outside lever is locked. Outside lever retracts latch bolt except when locked. Outside lever can only be locked with the solenoid. Inside lever always retracts latch bolt. Auxiliary latch deadlocks latch bolt.
EU = Power off, Locks outside lever by solenoid.
EL = Power on, Locks outside lever by solenoid.

All details subject to modification

Standard Mortise Lock Series SML Strikes

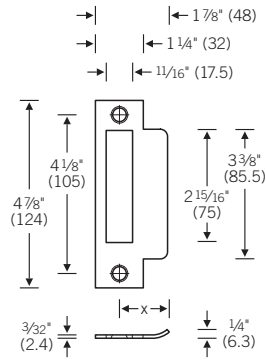

SML 1001

SML Series Mortise Strike (ANSI/ASA Strike) with dustbox

Standard **M1** = 1 1/4" (32 mm)

SML 1001 99

SML Series Extended Lip* Mortise Strike (ANSI/ASA Strike) with dustbox

* identify lip to center (x dimension)
specify mortise strike number

Mortise Strike Number	Lip To Center Dimension	ANSI Strike Type
M1	1 1/4"	Curved Lip
M2	1 1/8"	Curved Lip
M3	1 3/8"	Curved Lip
M4	1 1/2"	Curved Lip
M5	1 3/4"	Curved Lip
M6	2"	Curved Lip
M7	2 1/4"	Curved Lip
M8	2 1/2"	Curved Lip
M9	2 3/4"	Curved Lip
M10	3"	Curved Lip
M11	1 3/4"	Open Back
M12	2"	Open Back
M13	2 1/4"	Open Back

Functions D, I, J, and K are handed.

Standard Mortise Lock Series SML

Rabbeted Strikes and Band

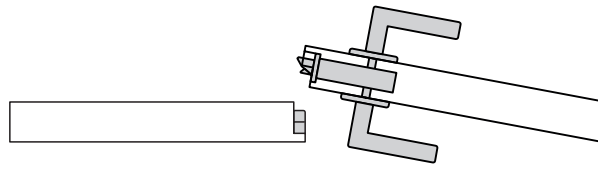

Standard - RFS1
Traditional - RFS2

Rabbet depth 1/2" deep centered within the door. Please specify lock number, door thickness, and finish.

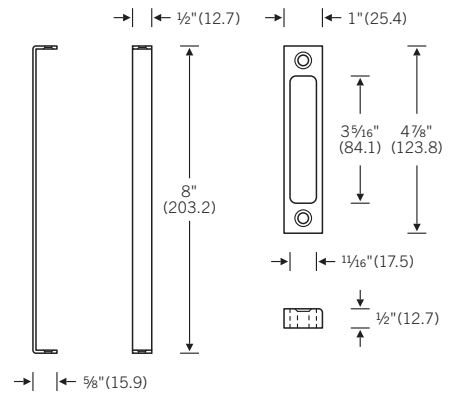
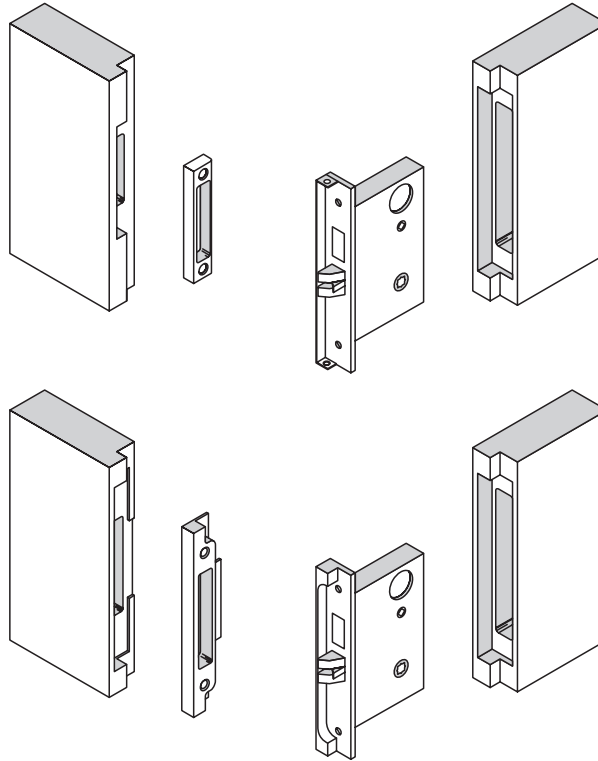

All details subject to modification

Electrified Mortise Lock Series SML

Lock Body and Functions



Series SML EL or SML EU

Recommended for minimum 1 3/4" (45 mm) door thickness with standard 1 1/4" (32 mm) armor front. 1" (25.4 mm) armor front available for doors with 1 3/8" (35 mm) door thickness.

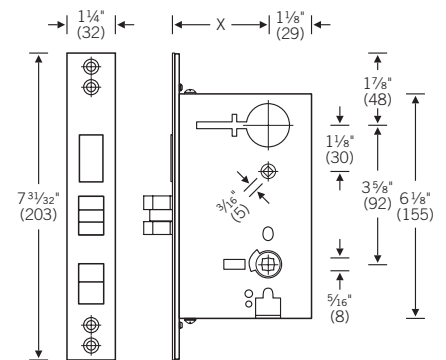

SML 7158 EU/EL

**Electrified Institutional,
JU/JL Function**

EU = fail secure
EL = fail safe



Solenoid activated mortise lock.

EL function – Inside and outside handles simultaneously locked electronically.
EU function – Inside and outside handles simultaneously unlocked electronically.

Latchbolt retracted by key on either side. Switched power allows both levers to retract latchbolt. Auxiliary latch deadlocks latch bolt.

Monitoring Options

RX = Request to Exit Switch
LM = Latchbolt Monitor Switch
DP = Door Position Switch

SML 7159 EU/EL

**Electrified Storeroom,
JU/JL Function**

EU = fail secure
EL = fail safe



Solenoid activated mortise lock.

EL function – Power ON, locks outside lever.
EU function – Power OFF, unlocks outside lever.

Outside lever can only be locked with the solenoid. Inside lever always retracts latch bolt. Auxiliary latch deadlocks latch bolt.

Monitoring Options

RX = Request to Exit Switch (monitors inside handle)
LM = Latchbolt Monitor Switch (monitors position of latchbolt)
DS = Door Position Switch (Monitors door via auxiliary latch)

Key outside retracts latch bolt, when outside lever is locked. Outside lever retracts latch bolt except when locked.

All details subject to modification

Narrow Mortise Lock Series NML

Lock Body and Functions



Series NML

Narrow Mortise Lock

Recommended for minimum 1 3/4" (45 mm) door thickness with standard 1 1/4" (32 mm) armor front. 1" (25.4 mm) armor front available for doors with 1 3/8" (35 mm) door thickness.

Backsets

- 1 1/2" (38 mm)
- 1 3/4" (45 mm)
- 2" (51 mm)
- 2 1/4" (57 mm)

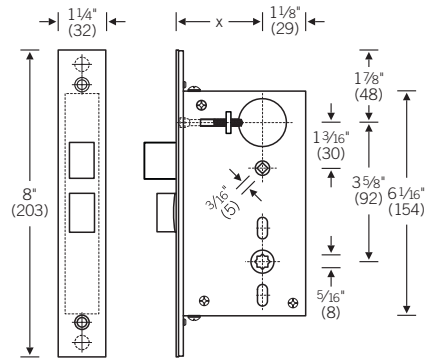

NML 7100

Active Dummy,
Y, Z Functions

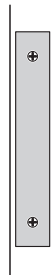

Active Dummy Mortise Case

Function Y

Active dummy handle either side.

Function Z

Active dummy handle single side only with blind cover on opposing side.

NML 7122



Store Door, Function A – ANSI Code F14

Latch bolt by handle either side. Deadbolt by key either side.

All details subject to modification

Narrow Mortise Lock Series NML

Lock Body and Functions

NML 7124



Dormitory, Function B – ANSI Code F13

Deadbolt by thumb turn inside and key or emergency release outside.

Privacy, Function E – ANSI Code F19

Latch bolt by handle either side. Deadbolt by thumbturn inside and emergency key outside. Use of inside handle retracts latch and deadbolt simultaneously, automatically unlocking outside handle. Outside handle is rigid when deadbolt is thrown by thumbturn.

Patio, Function T

Latch bolt by handle either side. Deadbolt by thumbturn inside. Outside handle is rigid when deadbolt is thrown by thumbturn. Use of inside handle retracts latch and deadbolt simultaneously.

NML 7125



Passage, Function C – ANSI Code F01

Latch bolt by handle either side.

NML 7142



Public Restroom, Function F – ANSI Code F09

Latch bolt by handle either side unless outside handle is locked by master key from inside (cylinders are provided KD). When outside handle is locked, latch bolt by key outside and handle inside. Auxiliary latch deadlocks latch bolt.

NML 7145



Classroom, Function G – ANSI Code F05

Latch bolt by key outside and handle either side unless outside handle is locked by key outside. Auxiliary latch deadlocks latch bolt.

All details subject to modification

Narrow Mortise Lock Series NML

Lock Body and Functions

NML 7148



Entrance, Function H – ANSI Code F12

Latch bolt by key outside and handle either side unless outside handle is locked by toggle. Deadbolt by key outside and thumbturn inside. Inside handle retracts latch and deadbolt. Outside handle is rigid when deadbolt is thrown by key or thumbturn.

NML 7156



Office, Function I – ANSI Code F04

Latch bolt by key outside and handle either side unless outside handle is locked by toggle. Auxiliary latch deadlocks latch bolt.

NML 7159



Storeroom, Function J – ANSI Code F07

Latch bolt by handle inside and key outside. Outside handle always rigid. Auxiliary latch deadlocks latch bolt.

NML 7181



Deadlock

Function M – ANSI Code F18

Deadbolt by key outside. No operation inside.

Function N – ANSI Code F16

Deadbolt by key either side.

Function P – ANSI Code F17

Deadbolt by key outside and thumbturn inside.

Function R

Deadbolt by thumbturn inside. No operation outside.

Function S

Deadbolt by thumbturn inside and emergency release outside.

All details subject to modification

Narrow Mortise Lock Series NML Strikes

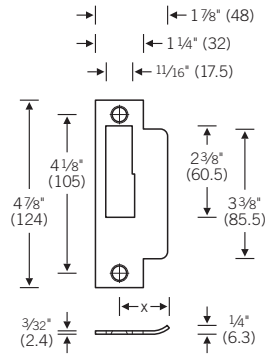

NML 1001

SML Series Mortise Strike (ANSI/ASA Strike) with dustbox

Standard **N1** = 1 1/4" (32 mm)

NML 1001 99

SML Series Extended Lip* Mortise Strike (ANSI/ASA Strike) with dustbox

* identify lip to center (x dimension)
specify mortise strike number

Narrow Mortise Strike Number	Lip To Center Dimension	ANSI Strike Type
N1	1 1/4"	Curved Lip
N2	1 1/8"	Curved Lip
N3	1 3/8"	Curved Lip
N4	1 1/2"	Curved Lip
N5	1 3/4"	Curved Lip
N6	2"	Curved Lip
N7	2 1/4"	Curved Lip
N8	2 1/2"	Curved Lip
N9	2 3/4"	Curved Lip
N10	3"	Curved Lip
N11	1 3/4"	Open Back
N12	2"	Open Back
N13	2 1/4"	Open Back

Strikes are handed. Please specify hand.

Rabbeted Strikes

Standard - NRFS1
Traditional - NRFS2

Rabbit depth 1/2" deep centered within the door.
Please specify lock number and door thickness.

All details subject to modification

SML and NML Mortise Lock Parts Spindles

05 0103

FSB half spindle



05 0103 00808	$\frac{5}{16}$ "	$\times 2\frac{3}{16}$ "	(8 × 55 mm)
05 0103 00812	$\frac{5}{16}$ "	$\times 2\frac{9}{16}$ "	(8 × 65 mm)
05 0103 00816	$\frac{5}{16}$ "	$\times 2\frac{15}{16}$ "	(8 × 75 mm)

05 0156

FSB straight spindle



Straight spindles available for DT (Door Thickness) up to 3 $\frac{3}{4}$ " (95 mm) on request.

05 0156 00822	$\frac{5}{16}$ "	$\times 3\frac{17}{32}$ "	(8 × 90 mm)
05 0156 00827	$\frac{5}{16}$ "	$\times 4\frac{1}{16}$ "	(8 × 103 mm)
05 0156 00830	$\frac{5}{16}$ "	$\times 4\frac{11}{32}$ "	(8 × 110 mm)
05 0156 00833	$\frac{5}{16}$ "	$\times 4\frac{19}{32}$ "	(8 × 117 mm)

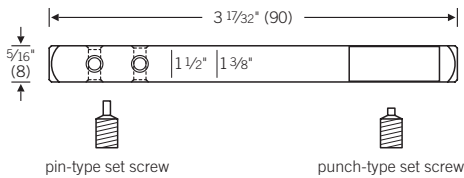

0156 00822

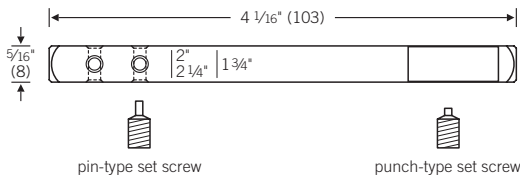

0156 00827

Installation Instructions for FSB Straight Spindles (0156)

1. Once the lock or latch has been properly fitted, remove the punch-type set screw from an FSB lever handle, insert the pin end of the FSB straight spindle up to the marking for the appropriate door thickness (DT), replace the set screw with the pin-type set screw provided with the straight spindle and tighten until the head of the set screw is lying flush with the surface of the handle shank.

Note: Ensure that the spring plate is in the same orientation as the initial set screw, facing out toward the leading edge of the door, to receive the opposite lever and punch-type set screw.

2. Firmly insert the FSB lever handle with spindle attached through the hub of the lock.

Thereafter fix the opposite handle over the inside end of the straight spindle while at the same time pressing the already fitted handle against that face of the door. Tighten punch-type set screw until the spring plate is pierced. This screw should now be lying flush with the surface of the handle as shown on the left page.

3. Once the lever handle set has been fitted, test the action several times by opening and closing the door. The lock spring is designed to return the handle to the horizontal position after operation. If the handle works stiffly, the fixing process should be repeated replacing or reversing the spindle's spring plate.

When ordering a standard FSB lockset or latchset, provide the appropriate door thickness to get the correct spindle length. To select the appropriate spindle separately please consult the spindle charts on the next page.

All details subject to modification

SML and NML Mortise Lock Parts

Spindles

05 0157



FSB swivel spindle

Swivel spindles available for DT (Door Thickness) up to 3¼" (95 mm) on request.

05 0157 02824	(8 × 96 mm)	1⅜"–1¾" DT
05 0157 02830	(8 × 110 mm)	2"–2½" DT
05 0157 02838	(8 × 130 mm)	2¾"–3¼" DT

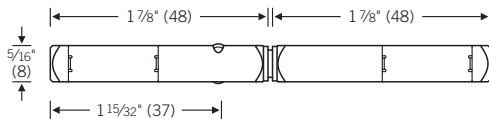

05 0157 02824

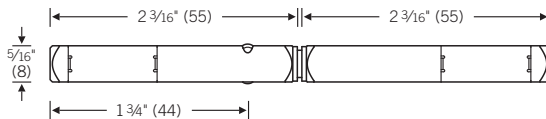

05 0157 02830

Installation instructions for FSB swivel spindles (0157)

1. Once the lock or latch has been properly fitted, guide the swivel spindle from outside until the washer stops the insertion movement, allowing for the spindle to fully engage the FSB mortise lock. This is a security precaution and allows both spring plates to be optimally located to receive the set screws of both handles.

Note: Ensure that both spring plates are in the same orientation and facing out toward the leading edge of the door, to receive the punch-type set screws.

2. Then, having attached the roses, fit the outside handle over the outside end of the swivel spindle and firmly tighten the punch-type set screw until the spring plate is pierced. The screw should now be lying flush with the surface of the handle shank.

3. Now firmly press the other handle over the inside end of the swivel spindle while at the same time pressing the already fitted handle against that face of the door. Tighten punch-type set screw as for other side.

4. Once the lever handle set has been fitted, test the action several times by opening and closing the door. The lock spring is designed to return the handle to the horizontal position after operation. If the handle works stiffly, the fixing process should be repeated replacing or reversing the spindle's spring plate.

Important note: Prior to inserting swivel spindle into any lock or latch, ensure that both spindle parts are separated by at least one rotation.

When ordering a standard FSB lockset or latchset, provide the appropriate door thickness to get the correct spindle length. To select the appropriate spindle separately please consult the spindle charts below.

Spindle Reference Guide

For use with 7 mm thick roses 1731, 1758 and 1798

DT	Swivel	Straight	Half
1⅜"	05 0157 02824	05 0156 00822	05 0103 00808
1½"	05 0157 02824	05 0156 00822	05 0103 00808
1¾"	05 0157 02824	05 0156 00827	05 0103 00812
2"	05 0157 02830	05 0156 00827	05 0103 00812
2¼"	05 0157 02830	05 0156 00827	05 0103 00812

All details subject to modification

2016/02

SML and NML Mortise Lock Parts

Adaptors and Fasteners

05 0425

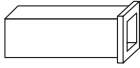

Adaptor sleeve

for lever handles spindles/lock follower

- 05 0425 00809 5/16" on 1 1/32" (8 on 9.0 mm)
- 05 0425 00810 5/16" on 1 3/32" (8 on 10.0 mm)
- 05 0425 00885 5/16" on 1 1/32" (8 on 8.5 mm)
- 05 0425 00910 1 1/32" on 1 3/32" (9 on 10.0 mm)

03 0440

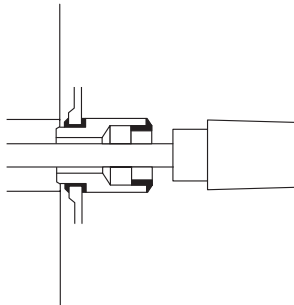

Lever handle distance rose to increase the distance between door and lever handle

Aluminum

- 03 0440 00020 2 5/32" (20 mm)
- 03 0440 00025 3 1/32" (25 mm)
- 03 0440 00030 1 3/16" (30 mm)

Stainless Steel

- 03 0440 00020 2 5/32" (20 mm)

03 0441

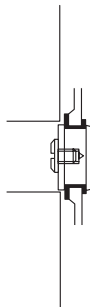

Blind rose

to blank out the lever handle hole on escutcheon plates

05 0526



Threaded rivets for metal doors

M5 3/16" x 3 1/32" (25 mm)

To be used with narrow style rose 1758.

SML and NML Mortise Lock Parts Fasteners

05 0302



Galvanized Steel Lens Head Tapping Screw

05 0302 04240	$\frac{5}{32}$ "	$\times 1 \frac{19}{32}$ "	(4.2 × 40 mm)
05 0302 04245	$\frac{5}{32}$ "	$\times 1 \frac{25}{32}$ "	(4.2 × 45 mm)
05 0302 04250	$\frac{5}{32}$ "	$\times 1 \frac{31}{32}$ "	(4.2 × 50 mm)
05 0302 04255	$\frac{5}{32}$ "	$\times 2 \frac{3}{16}$ "	(4.2 × 55 mm)
05 0302 04260	$\frac{5}{32}$ "	$\times 2 \frac{3}{8}$ "	(4.2 × 60 mm)
05 0302 04265	$\frac{5}{32}$ "	$\times 2 \frac{9}{16}$ "	(4.2 × 65 mm)
05 0302 04270	$\frac{5}{32}$ "	$\times 2 \frac{3}{4}$ "	(4.2 × 70 mm)
05 0302 04280	$\frac{5}{32}$ "	$\times 3 \frac{5}{32}$ "	(4.2 × 80 mm)

05 0303



Cross recessed raised countersunk oval head bolt

05 0303 00515	M5	$\frac{3}{16}$ "	$\times 1 \frac{9}{32}$ "	(15 mm)
05 0303 00535	M5	$\frac{3}{16}$ "	$\times 1 \frac{3}{8}$ "	(35 mm)

05 0309



Six bolts with M4 $\frac{5}{32}$ " threaded sleeve nut 0309

	Bolt length	Adjustable between	For door thickness
05 0309 00435	$1 \frac{3}{8}$ " (35 mm)	$1 \frac{15}{32}$ " – $1 \frac{25}{32}$ "	$\frac{31}{32}$ " – $1 \frac{5}{16}$ "
05 0309 00440	$1 \frac{19}{32}$ " (40 mm)	$1 \frac{21}{32}$ " – $1 \frac{31}{32}$ "	$1 \frac{3}{16}$ " – $1 \frac{1}{2}$ "
05 0309 00445	$1 \frac{25}{32}$ " (45 mm)	$1 \frac{27}{32}$ " – $2 \frac{3}{16}$ "	$1 \frac{3}{8}$ " – $1 \frac{11}{16}$ "
05 0309 00450	$1 \frac{31}{32}$ " (50 mm)	$2 \frac{1}{16}$ " – $2 \frac{3}{8}$ "	$1 \frac{19}{32}$ " – $1 \frac{7}{8}$ "
05 0309 00455	$2 \frac{3}{16}$ " (55 mm)	$2 \frac{1}{4}$ " – $2 \frac{9}{16}$ "	$1 \frac{25}{32}$ " – $2 \frac{3}{32}$ "
05 0309 00460	$2 \frac{3}{8}$ " (60 mm)	$2 \frac{7}{16}$ " – $2 \frac{3}{4}$ "	$1 \frac{31}{32}$ " – $2 \frac{9}{32}$ "

05 0314



M5 bolt

05 0314 00540	M5 × 40 mm	$1 \frac{19}{32}$ "
05 0314 00545	M5 × 45 mm	$1 \frac{25}{32}$ "
05 0314 00550	M5 × 50 mm	$1 \frac{31}{32}$ "
05 0314 00555	M5 × 55 mm	$2 \frac{3}{16}$ "
05 0314 00560	M5 × 60 mm	$2 \frac{3}{8}$ "
05 0314 00565	M5 × 65 mm	$2 \frac{9}{16}$ "
05 0314 00570	M5 × 70 mm	$2 \frac{3}{4}$ "
05 0314 00575	M5 × 75 mm	$2 \frac{31}{32}$ "
05 0314 00585	M5 × 85 mm	$3 \frac{3}{8}$ "

SML and NML Mortise Lock Parts

Alignment Tools

0423 9000

Alignment tool

For proper installation of FSB roses.

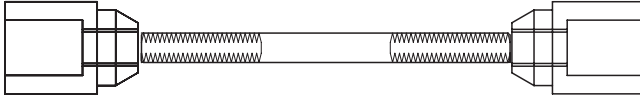

0423 9001

Alignment tool

To be used with all FSB Thumbturns and Turn and Release Sets which have a $\frac{3}{16}$ " (5 mm) diamond spindle.

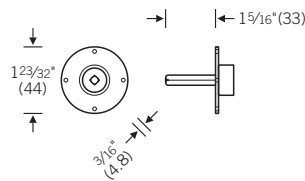
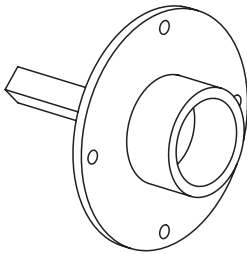

Proper alignment of the FSB thumbturn subrose over the hub of the mortise lock or tubular latch is critical. Misalignment of the subrose can result in deadbolt malfunction once the thumbturn is snapped in place. To avoid this issue from occurring, please use the thumbturn alignment tool provided in every appropriate FSB lockset or deadbolt set to mark the locations of the screws before fastening.

European Mortise Lock Series EML

Lock Body and Functions, Strikes



Series EML

European Mortise Lock

Recommended for minimum 1 3/8" (35 mm) door thickness.

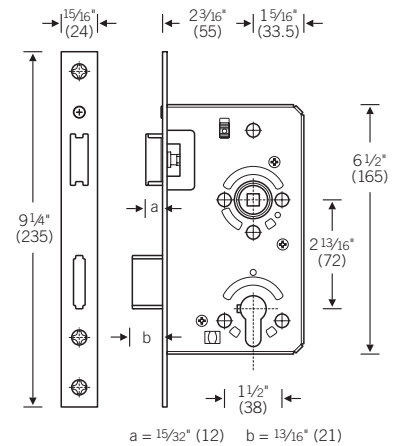

EML 0001

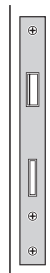

Store Door, Function A

Latch bolt by cylinder and handle either side unless deadbolt is in locked position. Deadbolt by key either side. Activated with key x key European profile cylinder. Lever to thumbturn center-to-center: 2 13/16" (72 mm).

Dormitory, Function B

Latch bolt by cylinder, turnpiece or handle either side unless deadbolt is in locked position. Deadbolt by key outside and turnpiece inside. Activated with key x turnpiece European profile cylinder. Lever to thumbturn center-to-center: 2 13/16" (72 mm).

All details subject to modification

European Mortise Lock Series EML

Lock Body and Functions, Strikes

EML 0002



Privacy, Function E

Latch bolt by handle either side unless deadbolt is in locked position. Deadbolt by emergency release outside and thumbturn inside connected by 8 mm spindle on the square.

Lever to thumbturn center-to-center: $3\frac{1}{16}"$ (78 mm).

EML 0003



Passage, Function C

Latch bolt by handle either side.

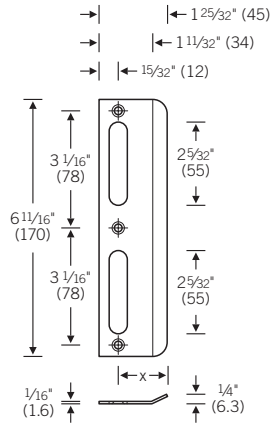

EML 1001

EML Series Mortise Strike without dustbox

Entry/Privacy Functions

Standard = $1\frac{5}{16}"$ (33 mm)

EML 1001 99

EML Series Extended Lip*
Mortise Strike without dustbox

* identify lip to center (x dimension)
specify mortise strike number

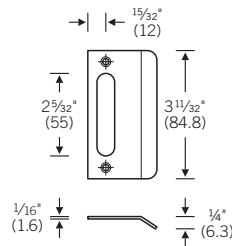

EML 1002

EML Series Mortise Strike without dustbox

Passage Function

All details subject to modification

European Mortise Lock Series EML Spindles

05 0115

FSB one sided spindle for doors drilled on one side



In choosing the correct FSB stabil-half-spindle, use the measurement of X as an aid. The measurement of X is the distance between the outer rim of the bushing of the backplates or roses and the lock follower.

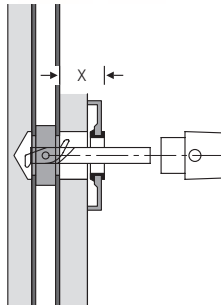

Dimension X

05 0115 00810	$\frac{5}{16}'' \times 2\frac{3}{8}''$ (8 × 60 mm),	$\frac{25}{32}'' - \frac{15}{16}''$ (20 – 24 mm)
05 0115 00812	$\frac{5}{16}'' \times 2\frac{9}{16}''$ (8 × 65 mm),	$\frac{31}{32}'' - 1\frac{5}{32}''$ (25 – 29 mm)
05 0115 00814	$\frac{5}{16}'' \times 2\frac{3}{4}''$ (8 × 70 mm),	$1\frac{3}{16}'' - 1\frac{11}{32}''$ (30 – 34 mm)
05 0115 00816	$\frac{5}{16}'' \times 2\frac{15}{16}''$ (8 × 75 mm),	$1\frac{3}{8}'' - 1\frac{17}{32}''$ (35 – 39 mm)
05 0115 00818	$\frac{5}{16}'' \times 3\frac{5}{32}''$ (8 × 80 mm),	$1\frac{19}{32}'' - 1\frac{5}{8}''$ (40 – 44 mm)

05 0402

Set screw with piercing punch



05 0402 00601	M6	$\frac{1}{4}'' \times \frac{5}{16}''$	(8,0 mm)
05 0402 00602	M6	$\frac{1}{4}'' \times \frac{11}{32}''$	(9,0 mm)
05 0402 00603	M6	$\frac{1}{4}'' \times \frac{13}{32}''$	(10,5 mm)
05 0402 00604	M6	$\frac{1}{4}'' \times \frac{7}{16}''$	(11,5 mm)

05 0406

Spring plate

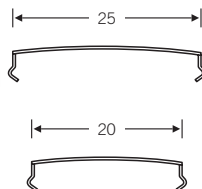

05 0406 02508	$\frac{31}{32}''$ (25 mm)
05 0406 02008	$\frac{25}{32}''$ (20 mm)

Used with Standard spindles 0156 and 0157.

05 0442

FSB stabil-blind-spindle



05 0442 00050

$\frac{5}{16}'' \times 2\frac{15}{16}''$ (8 × 75 mm), suitable for door thickness $1\frac{13}{32}''$ to $1\frac{25}{32}''$ (36 to 45 mm).