

6 Glass Door Locks

**6a European Swinging
Glass Door Locks**

3 Overview

4 Ordering String

6 Functions

8 European Glass Door Lock
Series EGS

10 European Glass Door Lock
Series EGR

12 European Glass Door Lock
Series EGC

14 Door Holder

15 Installation



Overview

EGS

13 4220

Pages 6



EGR

13 4223

Pages 8



EGC

13 4224

Pages 10



13 4230

Pages 12



All details subject to modification

Materials
and
Finishes

Aluminum

Stainless Steel

0105 (628)

0505 (703)

6204 (630)

0205

0704 (710)

6205 (629)

0305 (688)





0805 (711)

0405 (709)

Powder Coated

Specifying Locksets

European Swinging Glass Door Locks (EGS, EGR and EGC)

Glass Lock Type	Lock Functions	Lever Design	Trim Set	Thumbturn and Indicator																																																		
<h3>EGS</h3> <p>Insert your choice of glass door lock</p> <p>EGS European Glass Door Lock, Square Edge EGR European Glass Door Lock, Round Edge EGC European Glass Door Lock, Compact</p>	<h3>C</h3> <p>Insert your choice of function using one of the letter codes below.</p> <p>A Store Door C Passage E Privacy H Entrance</p> <p>European Glass Door Locks do not have Emergency Egress Function.</p>	<h3>1147</h3> <p>Insert your choice of lever design using one of the four digit codes.</p> <p>Levers</p> <table border="0"> <tr><td>1001*</td><td>1077</td></tr> <tr><td>1002*</td><td>1078</td></tr> <tr><td>1003*</td><td>1080</td></tr> <tr><td>1004*</td><td>1088</td></tr> <tr><td>1005</td><td>1093*</td></tr> <tr><td>1015</td><td>1102*</td></tr> <tr><td>1016</td><td>1106</td></tr> <tr><td>1020</td><td>1107</td></tr> <tr><td>1021</td><td>1108</td></tr> <tr><td>1023</td><td>1111**</td></tr> <tr><td>1025</td><td>1119</td></tr> <tr><td>1027</td><td>1126</td></tr> <tr><td>1028</td><td>1134*</td></tr> <tr><td>1031*</td><td>1144</td></tr> <tr><td>1034</td><td>1146</td></tr> <tr><td>1035*</td><td>1147</td></tr> <tr><td>1045</td><td>1160</td></tr> <tr><td>1051</td><td>1163*</td></tr> <tr><td>1053</td><td>1164*</td></tr> <tr><td>1057</td><td>1176</td></tr> <tr><td>1058</td><td>1177</td></tr> <tr><td>1070</td><td>1178</td></tr> <tr><td>1074*</td><td>1183*</td></tr> <tr><td>1075</td><td>1216</td></tr> <tr><td>1076</td><td>1241*</td></tr> </table> <p>* Aluminum available in natural color and RAL only ** Aluminum available in natural color only</p>	1001*	1077	1002*	1078	1003*	1080	1004*	1088	1005	1093*	1015	1102*	1016	1106	1020	1107	1021	1108	1023	1111**	1025	1119	1027	1126	1028	1134*	1031*	1144	1034	1146	1035*	1147	1045	1160	1051	1163*	1053	1164*	1057	1176	1058	1177	1070	1178	1074*	1183*	1075	1216	1076	1241*	<h3>RA</h3> <p>Insert your choice of trim set using one of the two letter codes.</p> <p>Optional Trim Set</p> <p>FL Patch fitting only RA Hard Edge Rose 2 3/16" (55 mm) (EGS + EGR only)</p>	<h3>S</h3> <p>Insert your choice of thumbturn and indicator if necessary.</p> <p>Thumbturns</p> <div style="display: flex; justify-content: space-around;">   </div> <p style="text-align: center;">S C</p> <p>Emergency Releases</p> <div style="display: flex; justify-content: space-around;">   </div> <p style="text-align: center;">N I</p>
1001*	1077																																																					
1002*	1078																																																					
1003*	1080																																																					
1004*	1088																																																					
1005	1093*																																																					
1015	1102*																																																					
1016	1106																																																					
1020	1107																																																					
1021	1108																																																					
1023	1111**																																																					
1025	1119																																																					
1027	1126																																																					
1028	1134*																																																					
1031*	1144																																																					
1034	1146																																																					
1035*	1147																																																					
1045	1160																																																					
1051	1163*																																																					
1053	1164*																																																					
1057	1176																																																					
1058	1177																																																					
1070	1178																																																					
1074*	1183*																																																					
1075	1216																																																					
1076	1241*																																																					

All details subject to modification

Material and Finish

6204

Insert your choice of material and finish using one of the four digit codes.

Aluminum Anodized

- 0105** Natural Color (628)
- 0205** Champagne Silver Color
- 0305** Brass Color (688)
- 0405** Light Bronze Color (709)
- 0505** Medium Bronze Color (703)
- 0704** Dark Bronze Color (710)
- 0805** Black Color (711)

Aluminum Powder Coated

- 8120** Black (671)
- 8220** White (714)

Stainless Steel

- 6204** Satin (630)
- 6205** Polished (629)

Backset

231

Available with 2³/₁₆" backset only

231 2³/₁₆"
(55 mm)
Backset

Strike

E1

Insert your choice of strike using one of the two letter codes below

Standard

- E1** Standard
- E2** Full Patch Strike

Handing

RH

Insert your choice of hand using one of the two letter codes below

- RH** Right Hand
- LH** Left Hand
- RR** Right Hand Reverse
- LR** Left Hand Reverse

Door Thickness

010

Insert your choice of door thickness using one of the three digit codes.

- 008** 8 mm
- 010** 10 mm
- 012** 12 mm

All details subject to modification

Example for Specifying

EGS - C - 1147 - RA - S - 6204 - 231 - E1 - RH - 010

European Glass Door Lock for Swinging Doors

Functions

Function A

Store Door

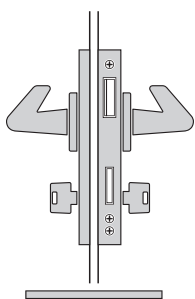

Latch bolt by handle either side.
Deadbolt by key either side.
European profile cylinder.

Lever to cylinder center-to-center:
 $2\frac{13}{16}$ " (72 mm).

Trim Sets

RA

FL

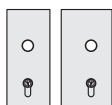
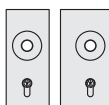

Function C

Passage

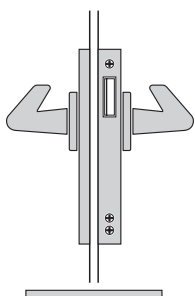

Latch bolt by handle either side.

Trim Sets

RA

FL

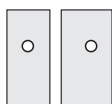
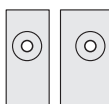

All details subject to modification

European Glass Door Lock for Swinging Doors

Functions

Function E

Privacy

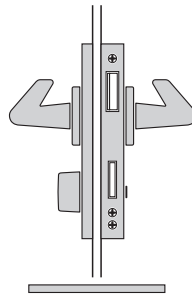

Latch bolt by handle either side.
Deadbolt by emergency release outside and thumbturn inside connected by 8 mm spindle on the square.

Lever to thumbturn center-to-center:
3 1/16" (78 mm).

Options

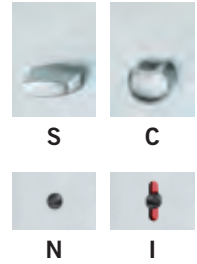

Trim Sets

RA-SN

FL-SN

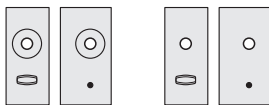

Options

RA-CN	FL-CN
RA-SI	FL-SI
RA-CI	FL-CI

Function H

Entrance

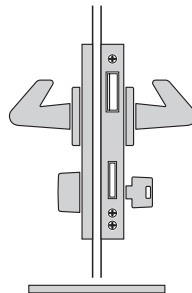

Latch bolt by handle either side.
Deadbolt by key outside and thumbturn inside.
European profile cylinder.

Lever to thumbturn center-to-center:
2 13/16" (72 mm).

Options

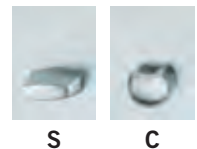

Trim Sets

RA-S

FL-S

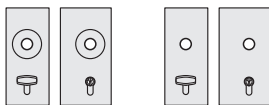

Options

RA-C	FL-C
-------------	-------------



All details subject to modification

European Glass Door Lock for Swinging Doors



Series EGS

13 4220 041   (LH)

13 4220 051   (RH)

Rectangular lockset plate with cover plates with heavy-duty glass door lock (DIN 18251, analogous to Class 4)

PZ cylinder CTC 72 mm

The handle shown is illustrative. Virtually any other FSB handle could be used instead.

European Glass Door Locks do not have Emergency Egress Function.



13 4220 042   (LH)

13 4220 052   (RH)

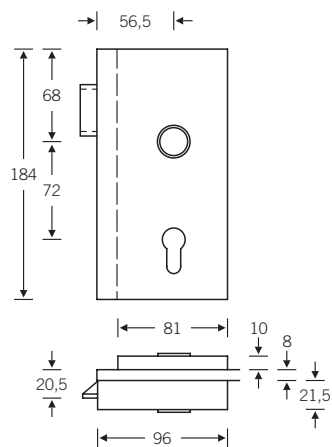

Technical notes:



Dimensions given assume glass 8 mm thick. Lockset plates for glass doors are prepared at the factory for glass 8 mm, 10 mm or 12 mm thick. Please specify.

Lock Functions are listed on pages 6 and 7.

European Glass Door Lock for Swinging Doors



Series EGR

13 4223 041  (LH)
13 4223 051  (RH)



Rectangular lockset plate rounded corners with cover plates with heavy-duty glass door lock (DIN 18251, analogous to Class 4)

PZ cylinder CTC 72 mm

The handle shown is illustrative. Virtually any other FSB handle could be used instead.

European Glass Door Locks do not have Emergency Egress Function.



13 4223 042  (LH)
13 4223 052  (RH)

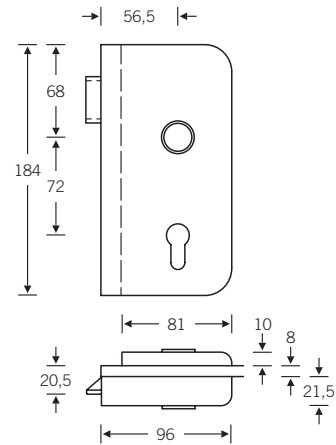

Technical notes:
Dimensions given assume glass 8 mm thick. Lockset plates for glass doors are prepared at the factory for glass 8 mm, 10 mm or 12 mm thick. Please specify.

Lock Functions are listed on pages 6 and 7.

All details subject to modification

European Glass Door Lock for Swinging Doors



Series EGC

13 4224 042  (LH)

13 4224 052  (RH)

Heavy-duty bearing
Rectangular lockset plate compact with
cover plates with heavy-duty glass door
lock (DIN 18251, Class 4)

PZ cylinder CTC 72 mm

8 mm split follower
cast-steel latch

The handle shown is illustrative.
Virtually any other FSB handle could be
used instead.

**European Glass Door Locks do not have
Emergency Egress Function.**

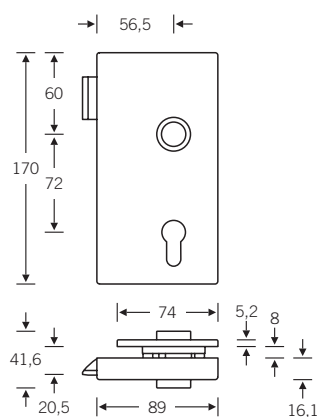

Technical notes:

Dimensions given assume glass 8 mm thick. Lockset
plates for glass doors are prepared at the factory for glass
8 mm, 10 mm or 12 mm thick. Please specify.

Lock Functions are listed on pages 6 and 7.





All details subject to modification

Strike

for Glass Walls or Pairs



13 4224

13 4224 045   (LH)
 13 4224 055   (RH)

Rectangular strike box compact to suit lockset plate for glass doors 4224 042/052.

The strike must be ordered in the hand opposite of the lock.

All details subject to modification

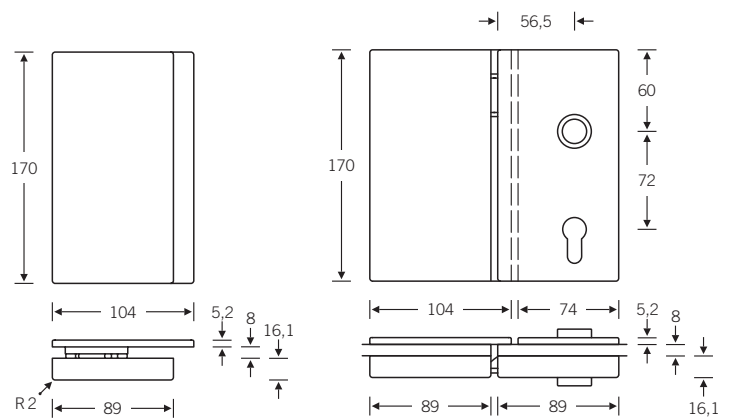

Technical notes:
 Strike boxes are prepared at the factory for 8 mm, 10 mm or 12 mm glass. Please specify.

Door Holder



13 4230 ■

Items nos.	A	B
13 4230 000	27 mm	8 mm
13 4230 010	29 mm	10 mm
13 4230 012	31 mm	12 mm

A = width overall, B = thickness of glass

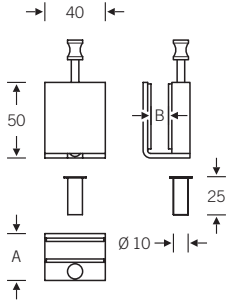

All details subject to modification

European Glass Door Lock Installation

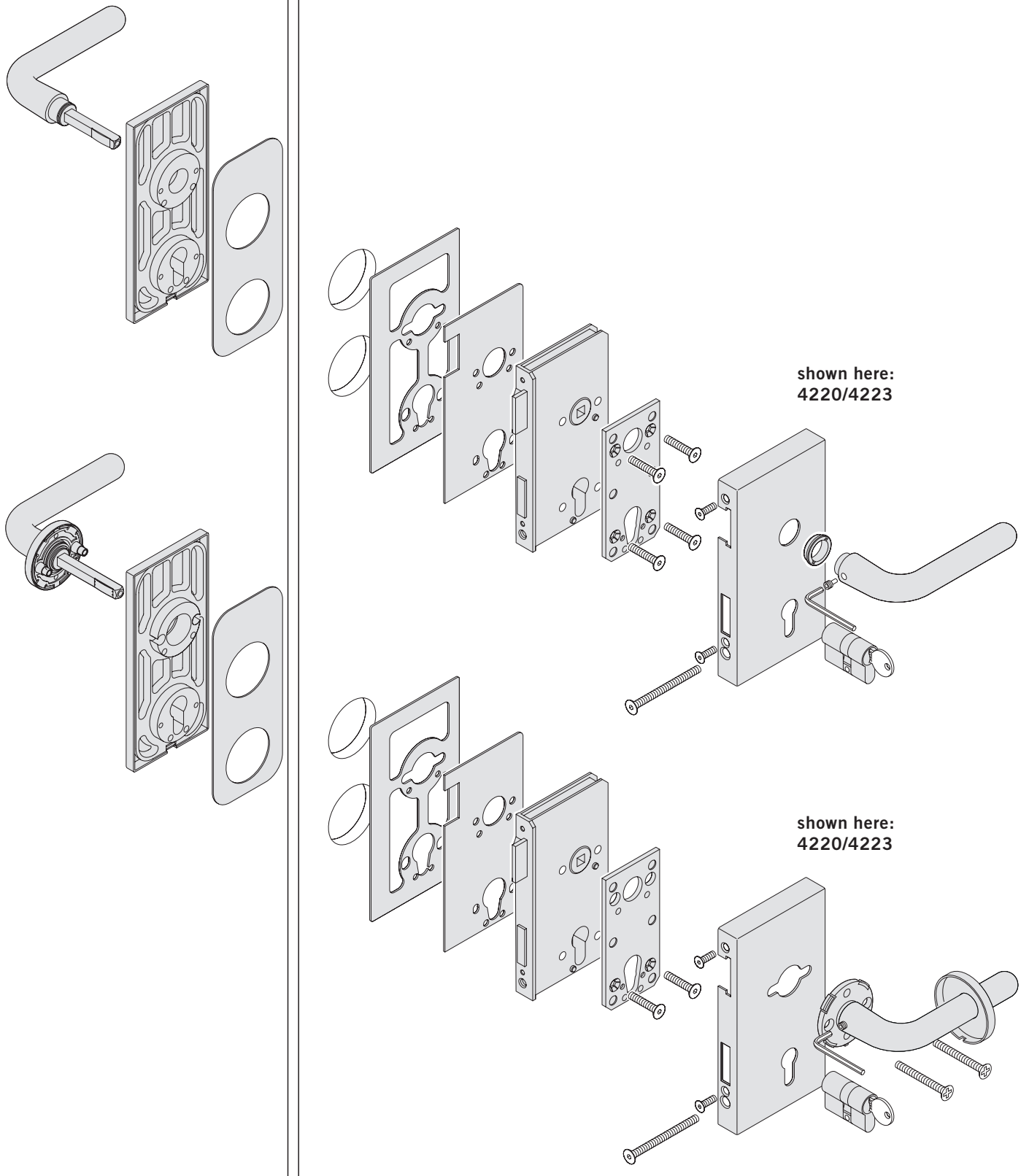

All details subject to modification

2016/02